

READ AND SAVE THESE INSTRUCTIONS

VAPOR-LOGIC[®]₂

MICROPROCESSOR HUMIDIFIER CONTROL SYSTEM

Installation Instructions and Operations Manual

For Toll-Free Technical Support,
Call 1-800-328-4447

DRI STEEM[®]
HUMIDIFIER COMPANY



TABLE OF CONTENTS

TO THE PURCHASER AND THE INSTALLER:

Thank you for deciding to purchase the VAPOR-LOGIC₂ microprocessor-based humidifier control system. We have designed and developed this microcontroller to give you total satisfaction and many years of trouble-free operation. Observing the installation and operating practices described in this manual will assure you of achieving that objective. We urge you to become familiar with the contents of this manual.

DRI-STEEM Humidifier Company

VAPOR-LOGIC₂ Program Code Nomenclature	3
Introduction	4
VAPOR-LOGIC₂ Control Board Installation	5
VAPOR-LOGIC₂ Control Board Operation	5
VAPOR-LOGIC₂ Key Pad/Digital Display Operation	6
Sensing Device Placement and Wiring	
Placement	8
Control Precautions	8
Humidistats and Transmitters	9
Proper Wiring Procedures	10
Auto Scroll Information	11
VAPOR-LOGIC₂ Main Menu Information	12
System Status Information	13
System Fault & Disable Conditions	14
Service Record	15
Warranty	16

VAPOR-LOGIC₂ PROGRAM CODE NOMENCLATURE

A six digit VAPOR-LOGIC₂ program code appears on the front of the control cabinet and on the wiring diagram inside of the control cabinet. The program code specifies the parameters necessary for the VAPOR-LOGIC microprocessor to control your system. An explanation of the program code is detailed below.

Example: Code number: VL2A4OOOX

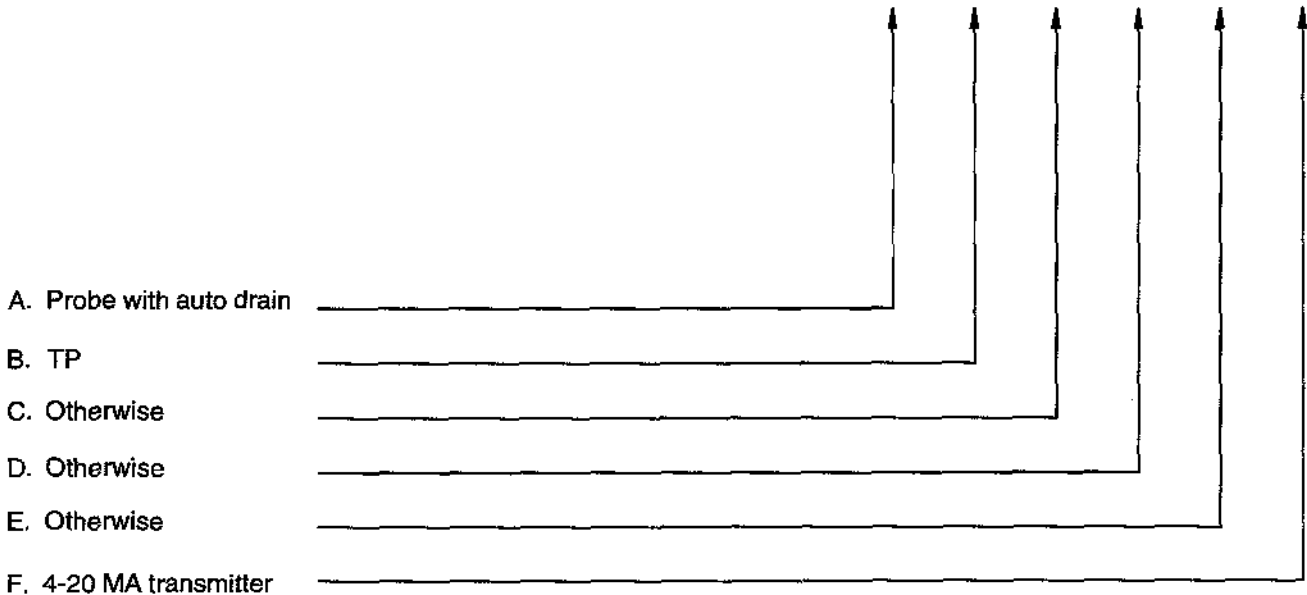

VAPOR-LOGIC₂ PROGRAM CODE

A. Type of water level control:
 VSDI with manual drain = D
 Probe with manual drain = M
 Probe with auto drain = A
 EOS/DI drain = E

B. Operating mode:
 Single staged = 1
 Externally staged = 2
 Zone valve = 3
 TP (Time Proportioning) = 4
 SCR (DIGITAL) = 5
 Steam valve (ANALOG) = 6

C. VAV options:
 V = Option
 O = Otherwise

D. Temp. comp. options:
 T = Option
 O = Otherwise

E. Aquastat options:
 A = Option
 O = Otherwise

F. Type of humidity sensing device:
 N = None, for off-on
 C = 0-135 ohms humidistat
 D = 6-9 VDC humidistat
 E = 4-20 MA humidistat
 X = 4-20 MA transmitter
 S = Special

INTRODUCTION

This manual explains the operation of and gives instructions for the use of the VAPOR-LOGIC₂ microcontroller. (See figure 4-1.)

VAPOR-LOGIC₂ is a custom microprocessor-based humidifier control system developed to be compatible with DRI-STEEM single stage humidifiers. (See figures 4-2, 4-3 and 4-4 below.) The versatile software is configured to meet the needs of humidification system control variations and to adapt to a multitude of humidifier applications. The advanced technology of

Figure 4-1: The key pad clearly displays the system functions of the humidifier.

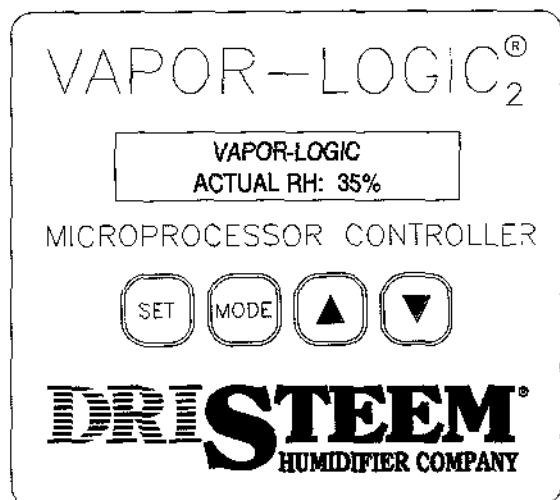
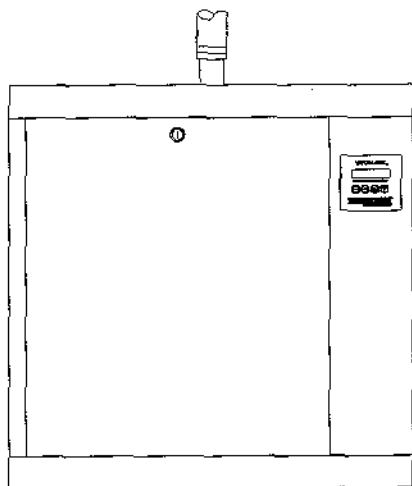

Figure 4-3: The VAPOR-LOGIC₂ key pad is mounted on the front of the VAPORMIST cabinet for easy access.



VAPOR-LOGIC₂ provides reliable operation while its simple operating procedures make it easy to use.

VAPOR-LOGIC₂ features include a self-diagnostic test during initialization, end-of-season drain and compatibility with most control inputs. A full-function integral digital display/key pad allows you to monitor and adjust humidifier control parameters.

VAPOR-LOGIC₂ controls single stage humidification systems with control accuracies to within $\pm 2\%$ RH.

Figure 4-2: The VAPOR-LOGIC₂ key pad is mounted on the CRU humidifier control cabinet, located near the unit.

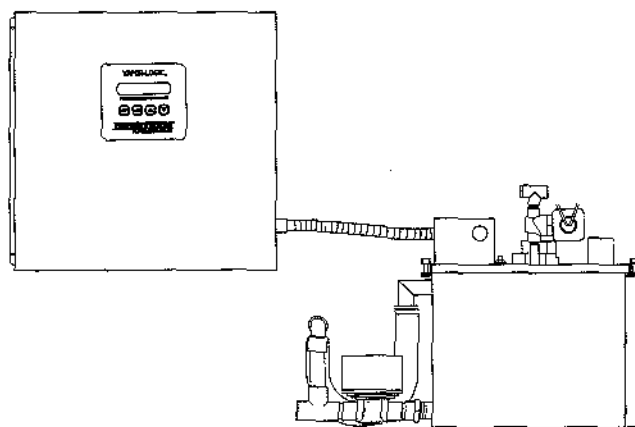
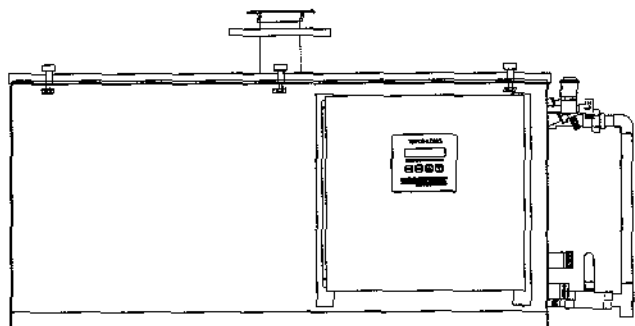

Figure 4-4: The STS and LTS humidifiers offer the flexibility of mounting the VAPOR-LOGIC₂ key pad on a control cabinet that is mounted on either the humidifier or on a wall near the humidifier.



VAPOR-LOGIC₂ CONTROL BOARD INSTALLATION

The VAPOR-LOGIC₂ control board is shipped factory mounted within a control cabinet with all internal wiring completed. All software has been custom programmed into your VAPOR-LOGIC₂ system according to the original order requirements. Refer to the VAPOR-LOGIC₂ control board drawing for detail of the board and connection points. (See figure 5-1.)

Never run control system wires bundled with, or in the same conduit as, line voltage wires.

All humidifier power wiring is represented on the humidifier wiring diagram. A wiring diagram and installation guide is attached to the inside of control cabinet door. All instructions should remain in the control cabinet after installation.

VAPOR-LOGIC₂ CONTROL BOARD OPERATION

Figure 5-1: VAPOR-LOGIC₂ printed circuit board

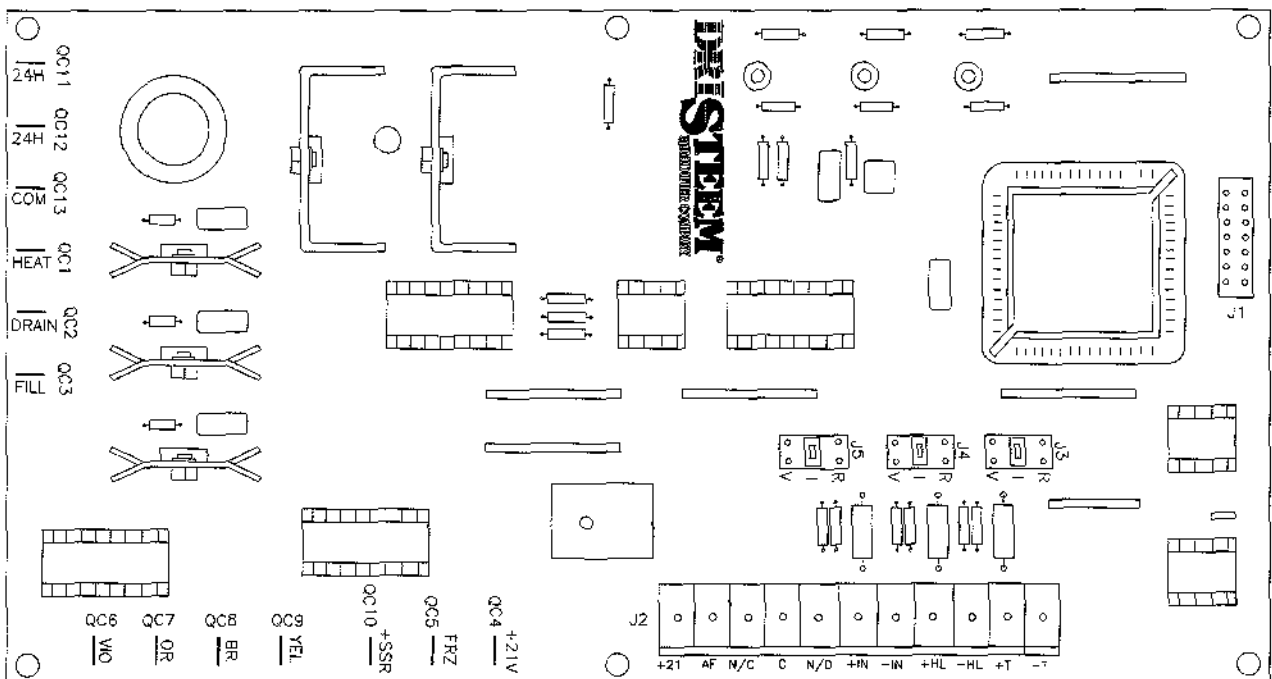

OM-613

No.	Description	No.	Description
J1	Alphanumeric Display Module Connector	QC-4	+21V 21 VDC Output to Freeze Stat
J2	Removable Terminal Strip to Reline Control Signals	QC-5	FRZ Receives 2, 21 VDC Input From Freeze Stat
J3	Jumper PIN Selects Analog Signal Type for Temperature Compensation Sensor	QC-6	BR Water Level, A
J4	Jumper PIN Selects Analog Signal Type for High Limit Humidity Sensor	QC-7	OR Water Level, B
J5	Jumper PIN Selects Analog Signal Type for Control Input Signal	QC-8	V10 Water Level, C
QC-1	Heat 24 Volt Output to Heater Contactor	QC-9	YEL Water Level Common
QC-2	Drain Drain Valve 24 VAC Output	QC-10	+SSR Modulating 1-9 VDC, DC Output
QC-3	Fill Fill Valve 24 VAC Output	QC-11	24H 24 VAC Hot
		QC-12	24H 24 VAC Hot
		QC-13	COM 24 VAC Common

VAPOR-LOGIC₂ OPERATION

Figure 6-1 : Conductivity probe system

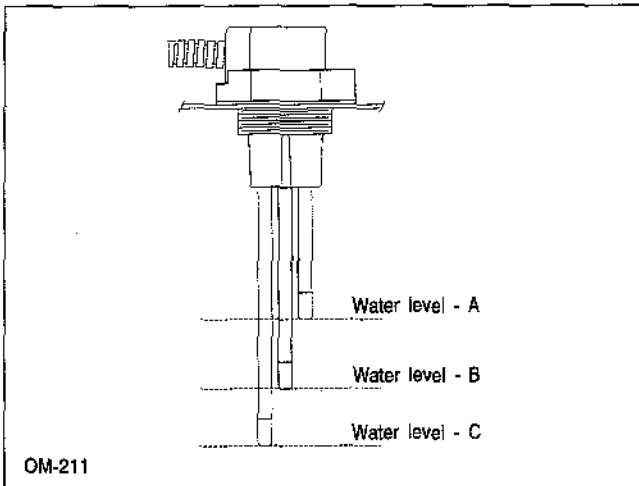

A conductivity probe system allows VAPOR-LOGIC₂ to control water levels for optimum operating efficiency. The three-probe system is monitored by the VAPOR-LOGIC₂ control, which performs all the necessary logic and timing functions to provide total water level control and safety shutdown.

VAPOR-LOGIC₂ automatically maintains the water level between the upper two probes A and B. (See figure 6-1.) When the water level falls below probe B, the fill valve is opened until the water level reaches the upper probe A. (A two second minimum delay is incorporated in the skim time software to ensure that turbulence does not cause an inaccurate fill reading.) An adjustable skim time allows for an extended skim period (2-60 seconds) to reduce mineral concentration within the humidifier. This adjustment can be accessed through the key pad main

menu. (See page 8.) Probe C provides low water protection for the heating elements. If the water level falls below probe C, the heat source is de-energized.

In addition to controlling the water level, VAPOR-LOGIC₂ determines when the heat source is energized. If there is a call for humidification, even during the fill cycle, the heat source will stay on to provide continuous output.

Auto Drain Sequence

VAPOR-LOGIC₂ is pre-programmed to enter an automatic drain, flush, and refill cycle based upon the actual time the humidifier has produced steam. VAPOR-LOGIC₂ is factory-set for a 40 hour (accumulated "ON" time) drain interval, with 8 minute drain and 8 minute flush durations. When VAPOR-LOGIC₂ initiates the auto drain sequence, the heaters are disabled. The drain valve is then opened to allow the tank to drain. At the end of the drain cycle the fill valve is opened, initiating the flush cycle. The drain valve remains open during the flush sequence to help dispose of sediment and precipitants. At the completion of the flush cycle, the drain valve closes, allowing the fill valve to refill the evaporating chamber. The VAPOR-LOGIC₂ timers are reset and the humidifier returns to normal "AUTO" operation.

End of Season Drain

If there is no call for humidification for a 72 hour period, VAPOR-LOGIC₂ automatically drains the humidifier. The drain valve is held open for one hour. The humidifier then switches into "STDBY" mode until there is a call for humidification, at which time VAPOR-LOGIC₂ automatically refills the evaporating chamber and resumes normal operation.

VAPOR-LOGIC₂ KEY PAD / DIGITAL DISPLAY OPERATION

The system is provided with an LCD display that has two lines with sixteen characters per line. This display provides all of the control, monitoring, and setup information.

The key pad has four keys that are used to set and control the system: SET, MODE, and the UP & DOWN ARROW keys. (See figure 6-2.)

Figure 6-2:
VAPOR-LOGIC₂ key
pad / digital display



SET

The SET key, if pressed while the system is in either AUTOMATIC or STANDBY mode, will display the Main Menu. (Note: if Access Code Protection has been selected, an additional step is necessary. See page 7 for further information.) Once in the Main Menu, pressing SET will move the digital display through the various Main Menu parameters.

MODE

The MODE key is used to place the system into one of four operating modes. Each time MODE is pressed, the system will move to the next mode: AUTO, STANDBY, DRAIN, and TEST.

The other three keys are multifunction keys whose function depends upon the current system mode.

VAPOR-LOGIC₂ KEY PAD / DIGITAL DISPLAY OPERATION

UP ARROW

The UP ARROW key is used, in the AUTOMATIC mode, to transfer one of the automatic scrolling items on the lower line to the upper line for constant monitoring. The item selected will be updated every few seconds and will remain isolated on the upper line while the other functions will continue scrolling on the lower line. Items that can be selected for constant monitoring are: Actual RH, Actual High Limit RH, Glass Temperature, Time until Recommended Service, Time until Automatic Drain and Flush Sequence, and Time until End of Season Drain.

If the system is in the DRAIN mode, pressing the UP ARROW key will open the drain valve.

If the system is in the TEST mode, pressing the UP ARROW key will start the test.

DOWN ARROW

The DOWN ARROW key is used, in the AUTOMATIC mode, to sequence through the auto scrolling items of the lower line. (To see the list of auto scrolling parameters, turn to page 11.)

If the system is in the DRAIN mode, pressing the DOWN ARROW key will close the drain valve.

If the system is in the TEST mode, pressing the DOWN ARROW key will halt the test.

OPERATING MODES

There are four operating modes: AUTO, STANDBY, DRAIN, and TEST. These different modes allow you to monitor and control the various operations of VAPOR-LOGIC₂. The digital displays vary considerably from mode to mode. The tables on pages 13 and 14 list all of the possible displays, along with their descriptions.

AUTO MODE

The AUTO mode allows for the normal operation of the humidifier. AUTO mode is the default mode of VAPOR-LOGIC₂ if power is interrupted.

In AUTO mode the upper line contains the review parameter you have selected and the lower line contains the auto scrolling parameters. (Remember: the UP ARROW key can be used to move through the possible review parameters on the upper line, while the DOWN ARROW key can be used to scroll through the parameters listed on the lower line.)

STANDBY MODE

When in STANDBY mode, the control outputs are turned off. Inputs continue to be monitored, and all programming functions are available. However, all outputs are disabled, and the water level in the evaporating chamber is not maintained. The drain timers and service timers do not accumulate time.

DRAIN MODE

DRAIN mode allows for manual control of the drain valve. The inputs are monitored and all other outputs are disabled. Programming functions are not accessible while in DRAIN mode. The drain valve can be opened and closed with the UP and DOWN keys respectively.

In DRAIN mode, the upper display will read "DRAIN MODE" while the lower display reads either "DRAIN OFF" or "DRAIN ON."

TEST MODE

The TEST mode turns on each control output one at a time to verify that each is performing correctly. All other functions are blocked. The TEST mode begins with a flashing "TEST MODE" message for five seconds. After this delay, the outputs are cycled individually. The heat or TSSR demand, the drain valve, and the fill valve are tested.

In TEST mode, the upper display will read "TEST MODE" while the lower display indicates the status of the test, or the output function being tested. For example, the lower line display could read: "FILL ON."

INITIALIZATION

When power is first applied to VAPOR-LOGIC₂, a short self-diagnostic test sequence is performed. During this test, the microprocessor and the non-volatile EEPROM memory are verified to be functioning properly. If a fault is detected, a fault message is displayed and humidifier operation stops. If no fault is detected, VAPOR-LOGIC₂ begins normal operation in the AUTO mode.

Accessing and Setting Main Menu Parameters

In either AUTO or STANDBY Mode, press the "SET" key to enter the Main Menu. (Note: The Access Code has been factory set to "00," and will not appear unless you have reset the Access Code. You may set the Access Code as you would any other parameter in the Main Menu.)

VAPOR-LOGIC[®]₂ KEY PAD / DIGITAL DISPLAY OPERATION

Once in the Main Menu, use the SET key to scroll through the items until the item you want is shown.

Use the UP and DOWN ARROW keys to change or set the parameter.

A service timer is included as a reminder to perform periodic maintenance and service to the humidifier. The

SERVICE timer display is included in VIEW and SCAN displays. The SERVICE timer advances when the control is in the AUTO mode. When the timer reaches zero, the message SERVICE is added to the SCAN display. Once the service timer has reached zero, it will continue to count, but in a negative fashion to indicate how many operating hours have elapsed since time out.

SENSING DEVICE PLACEMENT AND WIRING

Sensing Device Placement

The location of the humidity sensing device is very important to achieve accurate humidity control. A drawing of a typical small air handling system is shown below (figure 8-1). For the best control, place the humidity sensing device in the center of room, or just inside of the return air duct (location "A"). This will provide the least amount of variation caused by air flow patterns and room temperature. Placement of the duct high limit humidity sensing device (location "D") must be downstream from dispersion tubes a sufficient distance to ensure steam absorption has taken place. Accurate control of temperatures in rooms and ducts is also very important to improve control of relative humidity.

Control Precautions

Unsatisfactory humidifier control accuracy may involve more than just the controller's capability to control the system. Other factors that may play a role in overall system control accuracy are:

- Size of the humidification system.
- Overall system dynamics associated with moisture migration time lags.
- Accuracy of humidistats and humidity transmitters and their location.
- Dry bulb temperature accuracy in space or duct.
- Velocities and air flow patterns in ducts and space environments.
- Electrical noise or interference.

Figure 8-1: Humidistat control or humidity and temperature transmitters recommended placement

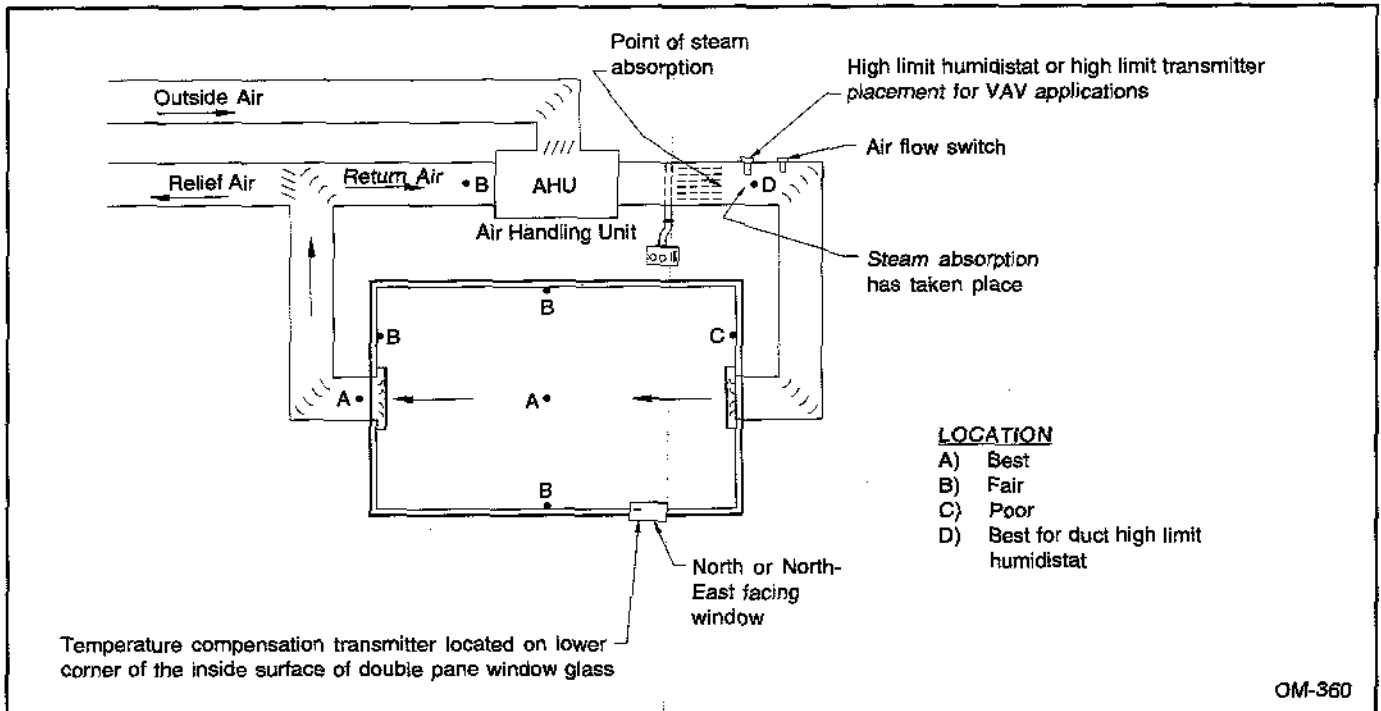

OM-360

SENSING DEVICE PLACEMENT AND WIRING

On/Off Humidistats*

DRI-STEEM may provide three types of on-off controls: a wall or a return air, duct mounted humidistat, or a pneumatic/electric relay.

Modulating Humidistats*

Humidistats can be supplied for either wall or duct mounted applications. These humidistats are powered by a 21 VDC supply provided by the VAPOR-LOGIC₂ control board. A 0-15 VDC modulated control signal is returned to the VAPOR-LOGIC₂ control board which modulates the output of the humidifier.

To use a signal from a pneumatic humidistat, DRI-STEEM can provide a transducer for a 3-20 psi pneumatic input range. This pneumatic input is converted to a 0-135 ohm signal. This 0-135 ohm signal is adaptable to the VAPOR-LOGIC₂ control board.

*Humidity set-point is made at the humidistat.

Modulating Humidity Sensors with Transmitters

DRI-STEEM can supply sensors with transmitters for either wall or duct mounted applications. They are powered by VAPOR-LOGIC₂ and have an output of 4-20 mA and a 0-100% RH range. (Humidity set-point is done at the VAPOR-LOGIC₂ keypad.)

OPTION: Variable Air Volume (VAV) Control Kit

When this system is ordered, a second modulating humidity sensor with transmitter is supplied (for duct mounting). This transmitter limits humidifier output during periods of low air flow to prevent saturation of air being humidified.

NOTE: The wiring diagram (found on the inside of the humidifier control cabinet) will show proper wiring for these controls.

Note: DRI-STEEM recommends using #18 gauge plenum rated shielded cable for transmitter wiring and grounding shield at a common point in control cabinet. (See figure 9-1.)

Figure 9-1: Shielded cable

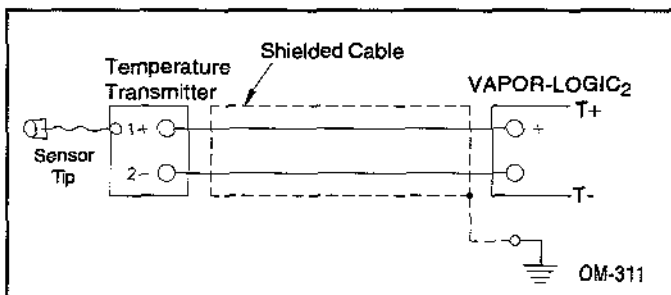

OPTION: Aquastat

This option protects the humidifier from damage due to freezing. Should the temperature of the water in the humidifier drop to near freezing the aquastat will energize the heat source as needed.

OPTION: High Limit Controller

This option is recommended for all duct humidifier applications. It is usually set for 90 to 95% RH and protects the duct system from condensation due to a rise in duct RH or drops in air temperature or air volume.

OPTION: Cold Snap RH Offset

This option prevents condensation from forming on windows during periods of frigid weather. It consists of a temperature sensor with transmitter mounted on an appropriate window to sense glass temperature. When the glass temperature falls below the dew point, the RH set point is automatically lowered. When the cold snap ends and the glass temperature rises, the normal RH setpoint is automatically restored.

Cold Snap Transmitter Placement (See figure 10-1.)

1. Position the cold snap transmitter control box on a wall adjacent to lower window framing and route the temperature sensor umbilical cord behind the wall and out through window framework.
2. Place the flat surface of the temperature sensor tip on the lower corner of the glass surface.
3. Temporarily hold the sensor tip in place with strips of masking tape.
4. Apply a small amount of clear RTV silicone adhesive over and around the sensor tip (making sure the sensor tip is in contact with the window glass).
5. After adhesive has cured, remove masking tape.

SENSING DEVICE PLACEMENT AND WIRING

Figure 10-1: Cold snap transmitter placement

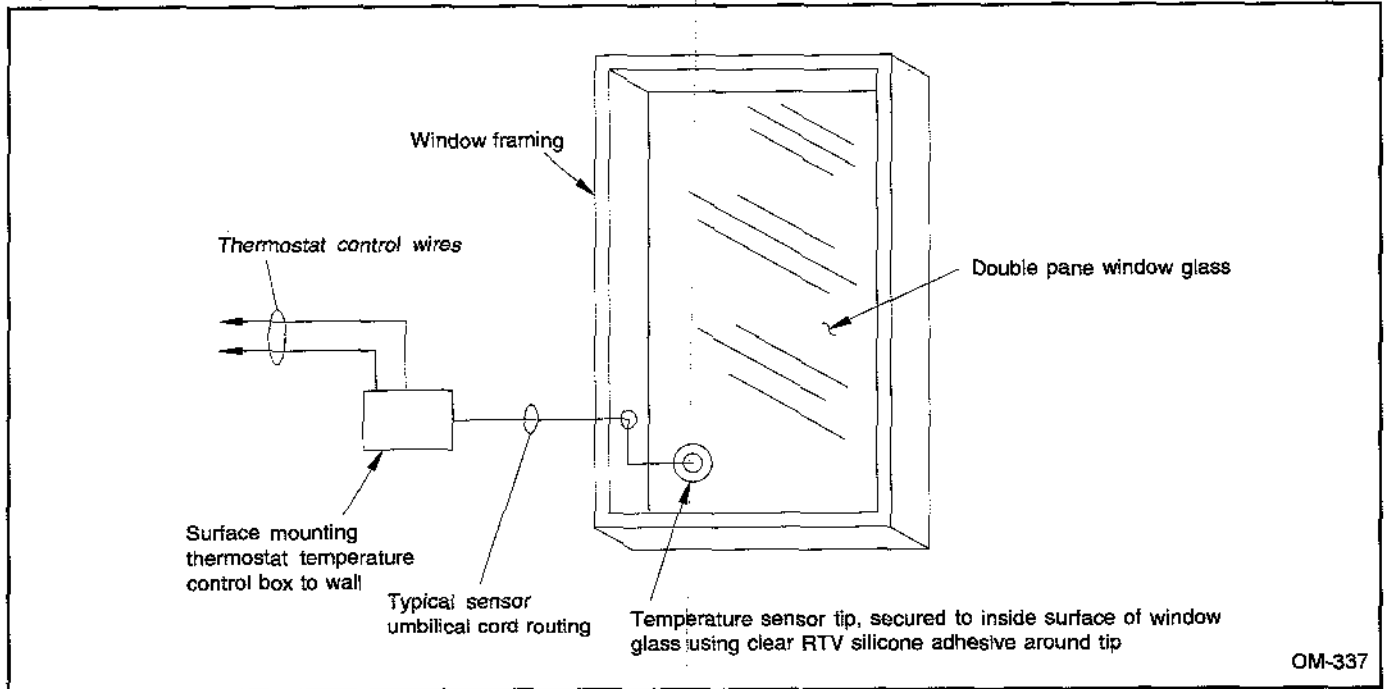

PROPER WIRING PROCEDURES

Electrical "noise" is generated by electrical equipment, such as switching loads, electric motors, solenoid coils, welding machinery, fluorescent light circuits, etc. This stray Electro-Magnetic Interface (EMI) can produce undesirable effects in electronic control circuits. The electrical "noise" or interference generated from these sources (and the effects on controllers) is very difficult to define, but most common symptoms are erratic operation or intermittent problems.

Most noise problems can be prevented by using wiring practices and techniques which inhibit coupling or inducing of electrical interference into control circuits. These simple wiring practices associated with DRI-STEEM humidifier equipment should minimize interaction of noise and controls:

- Humidifier and control cabinets must be connected to a code approved earth ground.
- When routing electrical wiring inside the control cabinet, separate line voltage wiring from low voltage control circuit wiring.

- Use separate electrical conduits for line and low voltage wiring from the humidifier to humidity sensors, airflow switches, etc.
- Do not mix chassis or safety grounds with current carrying commons. No safety grounds should ever be used as a conductor or neutral to return circuit current.
- The preferred method of external electrical connections to humidistats, room/duct humidity and temperature transmitters, and control signal input connections from building control systems is minimum #18 gauge plenum rated wire cable of twisted pair type, BELDEN #88760, including cable shielding and drain wire for grounding.
- All grounding of shielded cable connections should be returned to the control cabinet and tied to the earth ground point. Do not ground shield at the device end.

NOTE: Do not use shielded cable for probe wiring. Individual #18 gauge stranded is recommended.

AUTO SCROLL INFORMATION

The following pages contain information about the digital read-outs that VAPOR-LOGIC[®] displays on the key pad. This includes a wide variety of present system conditions, faults, and programmable parameters that ultimately control the humidification system. The charts are organized based upon when or why the information is communicated.

Auto Scroll:

The items that will continuously scroll on the lower line during normal humidifier operation are listed below. The current conditions are monitored and communicated through VAPOR-LOGIC₂. The items available for individual review on the upper line are noted.

AUTO SCROLL DESCRIPTION	AUTO SCROLL READ-OUT (LOWER LINE DISPLAY)	AVAILABLE FOR UPPER LINE REVIEW
Relative Humidity Set Point	"DESIRED RH __%"	NO
Actual Relative Humidity	"ACTUAL RH __%"	YES
Maximum High Limit Humidity	"MAX HL RH __%"	NO
Actual High Limit Humidity	"ACT HL RH __%"	YES
Window Glass Temperature	"GLASS TEMP ± __°F"	YES
Total Percentage System Output	"SYS DEMAND __%"	NO
Time until Service Message Display * (in hours)	"SERVICE __H"	YES
Time until Automatic Drain and Flush (in hours)	"AUTO DRAIN __H"	YES
Time until End of Season Drain (in hours)	"EOS DRAIN __H"	YES
Setpoint Temperature Compensation Reduction	"TEMP COMP __%"	NO

* Clearing the Service Timer

1. Energize unit.
2. Once the unit has finished initializing, push the MODE key until the display says STANDBY MODE.
3. Once in STANDBY MODE, push the SET button. If the display says ENTER CODE, skip to step 7 now.
4. The display should now say SCAN TIME. Push the SET button until the display says ACC CODE.
5. Push the 'Up Arrow' once to enter an access code of 01. Press the MODE key.
6. After the display says SAVE MODE and returns to the STANDBY MODE, press SET button again. The display should now say ENTER CODE.
7. To reset the SERVICE Timer to the SERVICE interval parameter value, a special Access Code must be entered. Press the SET key to display the ENTER CODE message. Use the UP and DOWN keys to set the Access Code to '2345'. Press the SET key a second time to enter the code. The display will return to the AUTO MODE, but the SERVICE Timer will be reset. The Access Code parameter ACC CODE may be set to any non-zero value and does not need to be set to the special Reset Code.

VAPOR-LOGIC[®] MAIN MENU INFORMATION

Main Menu Descriptions:

The Main Menu items are available by pressing the SET key while in either AUTO or STNDBY mode. The SET key also allows you to scroll through the items in the Main Menu. While in the Main Menu, you may view or change the system parameters by following the instructions on page 8.

Note: If any of the options were not selected by the original customer humidifier order, that specific parameter would be removed from the Main Menu.

If parameter values are changed, they take effect immediately without waiting for the EEPROM SAVE to effect the system operation. (EEPROM is short for Electronically Erasable Programmable Read Only Memory chip.)

The following is a list of the parameters, their setting ranges, and their default settings.

IMPORTANT: Do not set "Cycle Rate" less than 15 seconds when time proportioning contactors.

MAIN MENU DESCRIPTION	READ-OUT	RANGE	FACTORY SET DEFAULT
Message Scan Delay Time*	"SCAN TIME __S"	0-10 seconds	3 seconds
Relative Humidity Setpoint	"DESIRED RH __%"	20-95%	35%
Maximum High Limit Humidity	"MAX HL RH __%"	20-95%	70%
Automatic Drain and Flush Interval	"ADS INT __H"	0-99 hours	40 hours
Automatic Drain Duration*	"ADS DUR __M"	0-30 minutes	8 minutes
Automatic Flush Duration*	"AFS DUR __M"	0-30 minutes	8 minutes
Access Code To Allow Set Up*	"ACC CODE ____"	0-9999	00
Time Proportioning Interval	"CYCLE RATE __S"	4-25 seconds (SCR) 15-60 seconds (contactor)	25 seconds
Proportional Band	"PROP BAND __%"	2-20%	10%
Reset (Integral) Interval*	"RESET __M"	0-19.9 minutes	.5 minute
Skim Time	"SKIM TIME __S"	2-60 seconds	2 seconds
Calibration Offset for RH	"CAL RH ± __%"	-10% - +10%	0%
Calibration Offset for HL RH	"CAL HL RH ± __%"	-10% to +10%	0%
Calibration Offset for Temperature	"CAL TEMP ± __°F"	-10°F to +10°F	0°F

* These parameters, if set to zero, will eliminate the function from the humidification system. You may re-select the function at any time by changing the parameter in the Main Menu to a value other than zero.

VAPOR-LOGIC[®]₂ SYSTEM STATUS INFORMATION

DIGITAL DISPLAY SYSTEM STATUS READ-OUT	SYSTEM STATUS DESCRIPTION
"AUTO MODE"	The system is in AUTO MODE, which allows for the normal operation of the humidifier. (Default mode at start-up.)
"STANDBY MODE"	The system is in STANDBY MODE, which turns off all control outputs during periods of servicing. Programming functions are available. Electrical power must be shut off at the disconnect before servicing electrically heated humidifiers.
"DRAIN MODE"	The system is in DRAIN MODE, which turns off all control outputs during periods of servicing. Programming functions are not available.
"TEST MODE"	The system is in TEST MODE, which is used to verify the performance of the individual control outputs.
"DRAIN ON"	The Automatic or Manual Drain has been activated, during normal operating procedures.
"FLUSHING"	The system is in the Flush Interval of the Auto Drain sequence.
"EOS DRAIN ACTIVE"	The humidifier has not been active for 72 hours and has activated the End of Season Drain.
"FILL ON"	The Fill Valve has been activated.
"AQUASTAT ENABLE"	The heater has been enabled or activated by the aquastat.
"BEGINNING TEST"	When the test cycle has been initially activated, this pre-test message appears.
"HEAT OFF"	This designates part of the Heater Output test: heater contactor/valve has been turned off.
"HEAT ON"	This designates part of the Heater Output test: heater contactor/valve has been turned on.
"DRAIN OFF"	This designates part of the Drain Output test: drain valve has been closed.
"DRAIN ON"	This designates part of the Drain Output test: drain valve has been opened.
"FILL OFF"	This designates part of the Fill Output test: fill valve has been closed.
"FILL ON"	This designates part of the Fill Output test: fill valve has been opened.
"SERVICE"	DRI-STEEM recommends inspecting and, if necessary, cleaning your humidifier system at this time.
"+SSR OFF"	This designates the +SSR output test when the output is configured as a digital output for SCR and SSRs: 0 VDC at output.
"+SSR ON"	This designates the +SSR output test when the output is configured as digital output for SCR and SSRs: 10 VDC at output.
"+SSR ANALOG OFF"	This designates the +SSR output test when the output is configured as an analog output for modulating valves: 0 VDC at output.
"+SSR ANALOG ON"	This designates the +SSR output test when the output is configured as an analog output for modulating valves: the output varies between 0 and 10 VDC.

SYSTEM FAULT & DISABLE CONDITIONS

Fault Conditions

The system continuously monitors for a wide variety of FAULT conditions. When a FAULT occurs, the status of the system is changed to "FAULT" and the appropriate description appears in the lower line display. A FAULT condition shuts off all of the humidifier outputs.

All faults deactivate the demand for heat. If the fault is a "FILL" fault, the line voltage must be interrupted to reset the system. All other faults are AUTOMATIC RESET, and the fault will automatically clear once the condition no longer exists and the system then proceeds as normal.

SYSTEM FAULT READ-OUT	SYSTEM FAULT DESCRIPTION	RECOMMENDED ACTION
"FAULT SYSTEM ERROR"	A failure condition has been detected during self-diagnostics test. (Microprocessor or EEPROM fault.)	Consult DRI-STEEM.
"FAULT LIQUID LEVEL SEN"	An error has been detected in the sequencing of the probe.	Clean probe rod assembly.
"FAULT FILL TIMER OVER"	The FILL has not been completed during the set FILL time. (Tank is not full.)	Check water supply shut off valve. Check inline strainer. Check for voltage present at the valve (when filling).
"FAULT DRAIN FAULT ACT"	The DRAIN has not been completed during the set DRAIN time. (Tank is not empty.)	Check for plugged tank drain outlet, clean. Check for voltage present at the valve (when in DRAIN mode).
"FAULT SENSOR"	The RH Transmitters or Temperature Transmitter have detected invalid readings (too low).	Check for open, shorted, or incorrect wiring.

Disable Conditions

The humidifier may be disabled by three conditions. These disabling conditions are not faults as they are expected to occur in normal operation of the system. They are temporary interruptions to the normal operation of the humidifier. They are indicated by a message on the second line of the display. Once the condition has been corrected the humidifier will resume operation automatically.

SYSTEM DISABLE READ-OUT	SYSTEM DISABLE DESCRIPTION	RECOMMENDED ACTION
"AFPS DISABLE"	The Air Flow Proving Switch has detected too little air flow.	Check for proper air flow: blowers, filters, coils, etc.
"HL RH DISABLE"	The actual duct relative humidity has exceeded the programmed upper limit.	Check for low duct temperature and proper air flow.
"LO WATER DISABLE"	A low water level has been detected in the tank.	Check water supply.

TWO YEAR LIMITED WARRANTY

DRI-STEEM Humidifier Company ("DRI-STEEM") warrants to the original user that its products will be free from defects in materials and workmanship for a period of two (2) years after installation or twenty-seven (27) months from the date DRI-STEEM ships such product, whichever date is the earlier.

If any DRI-STEEM product is found to be defective in material or workmanship during the applicable warranty period, DRI-STEEM's entire liability, and the purchaser's sole and exclusive remedy, shall be the repair or replacement of the defective product, or the refund of the purchase price, at DRI-STEEM's election. DRI-STEEM shall not be liable for any costs or expenses, whether direct or indirect, associated with the installation, removal or re-installation of any defective product.

DRI-STEEM's limited warranty shall not be effective or actionable unless there is compliance with all installation and operating instructions furnished by DRI-STEEM, or if the products have been modified or altered without the written consent of DRI-STEEM, or if such products have been subject to accident, misuse, mishandling, tampering, negligence or improper maintenance. Any warranty claim must be submitted to DRI-STEEM in writing within the stated warranty period.

DRI-STEEM's limited warranty is made in lieu of, and DRI-STEEM disclaims all other warranties, whether express or implied, including but not limited to any IMPLIED WARRANTY OF MERCHANTABILITY, ANY IMPLIED WARRANTY OF FITNESS FOR A PARTICULAR PURPOSE, any implied warranty arising out of a course of dealing or of performance, custom or usage of trade.

DRI-STEEM SHALL NOT, UNDER ANY CIRCUMSTANCES BE LIABLE FOR ANY DIRECT, INDIRECT, INCIDENTAL, SPECIAL OR CONSEQUENTIAL DAMAGES (INCLUDING, BUT NOT LIMITED TO, LOSS OF PROFITS, REVENUE OR BUSINESS) OR DAMAGE OR INJURY TO PERSONS OR PROPERTY IN ANY WAY RELATED TO THE MANUFACTURE OR THE USE OF ITS PRODUCTS. The exclusion applies regardless of whether such damages are sought based on breach of warranty, breach of contract, negligence, strict liability in tort, or any other legal theory, even if DRI-STEEM has notice of the possibility of such damages.

By purchasing DRI-STEEM's products, the purchaser agrees to the terms and conditions of this limited warranty.

DRI-STEEM[®]
HUMIDIFIER COMPANY



14949 Technology Drive • Eden Prairie, MN 55344
Phone: (612) 949-2415 • Fax: (612) 949-2933
E-Mail: sales@dristeem.com • Web: www.dristeem.com

Europe Office:

Bell Place, Bell Lane • Syresham, Brackley • NN13 5HP, U.K.
Phone: +44 1280 850122 • Fax: +44 1280 850124
E-Mail: 106277.1443@compuserve.com



Printed on recycled paper.
Minimum 10% Post Consumer Waste